



GM 2019 4WD 1500 3.5 Inch Lift Kit

Thank you for choosing Rough Country for your suspension needs.

Rough Country recommends a certified technician install this system. In addition to these instructions, professional knowledge of disassemble/reassembly procedures as well as post installation checks must be known. Attempts to install this system without this knowledge and expertise may jeopardize the integrity and/or operating safety of the vehicle.

Please read instructions before beginning installation. Check the kit hardware against the parts list on the rear cover of these instructions. Be sure you have all needed parts and know where they go. Also please review tools needed list and make sure you have needed tools.

PRODUCT USE INFORMATION

⚠ WARNING As a general rule, the taller a vehicle is, the easier it will roll. Seat belts and shoulder harnesses should be worn at all times. Avoid situations where a side rollover may occur. Generally, braking performance and capability are decreased when larger/heavier tires and wheels are used. Take this into consideration while driving. Do not add, alter, or fabricate any factory or after-market parts to increase vehicle height over the intended height of the Rough Country product purchased. Mixing component brands is not recommended.

Rough Country makes no claims regarding lifting devices and excludes any and all implied claims. We will not be responsible for any product that is altered. If question exist we will be happy to answer any questions concerning the design, function, and correct use of our products.

⚠ NOTICE The electric power steering must be unplugged before any of the steering components are removed. Failure to do so may cause damage to the electric power steering.

⚠ NOTICE Trucks equipped with a mass damper on the front diff, the damper will have to be removed.

This kit is packaged as a leveling kit—raising the front 3.5” and the back 2.5”. If you desire a different look or if the vehicle has a tool box or added weight in the rear, please consult with your sales representative about other block and u-bolt options.

This suspension system was developed using a 295/60R20 tire on the factory 20” wheel. If wider tires are used trimming may be required. Due to manufacturing, dimension variances, and inflation, all tire and wheel combinations should be tested prior to installation on all oversized / wider then stock tires and wheels.

⚠ NOTICE Fits crew cab short bed models only. Will not fit models with adaptive ride control and will not fit GMC AT4 or Chevy Trail Boss models.

⚠ NOTICE DEALER AND VEHICLE OWNER

Any vehicle equipped with any Rough Country product should have a “Warning to Driver” decal installed on the inside of the windshield or on the vehicle’s dash. The decal should act as a constant reminder for whoever is operating the vehicle.

Tools Needed:

Floor Jack /Jack Stands	36mm socket
10mm socket /wrench	1/2” socket/wrench
13 mm socket/wrench	9/16” socket /wrench
15mm socket / wrench	3/4” socket/wrench
17mm socket/wrench	T30 Torx bit
18mm socket /wrench	Reciprocating Saw
21mm socket /wrench	Hammer
22mm socket /wrench	Locking Pliers
24mm socket /wrench	
27mm socket /wrench	

Torque Specs:

Size	Grade 5	Grade 8	Size	Class 8.8	Class 10.9
5/16”	15 ft/lbs	20 ft/lbs	6MM	5 ft/lbs	9 ft/lbs
3/8”	30 ft/lbs	35 ft/lbs	8MM	18ft/lbs	23 ft/lbs
7/16”	45 ft/lbs	60 ft/lbs	10MM	32ft/lbs	45ft/lbs
1/2”	65 ft/lbs	90 ft/lbs	12MM	55ft/lbs	75ft/lbs
9/16”	95 ft/lbs	130 ft/lbs	14MM	85ft/lbs	120ft/lbs
5/8”	135 ft/lbs	175 ft/lbs	16MM	130ft/lbs	165ft/lbs
3/4”	185 ft/lbs	280 ft/lbs	18MM	170ft/lbs	240ft/lbs

KIT CONTENT



Kit Contents

29531 (Kit)

29501 Forged Aluminum Arms x1
295BOX2 x1
20158 N3 Rear Shocks x2

29501 (Upper Control Arms):

Forged Aluminum Dr Upper Arm x1
Forged Aluminum Pass Upper Arm x1
29501BAG1 x1
Ball Joint Hardware Bag x2

295Box2 (4WD Lift Kit)

Upper Strut Spacers x2
Strut Spacer Preload x2
2.5" Rear Blocks x2
295INSTBAG2 x1
275BAG3 x1
9/16 X 2 1/2 X 10 1/2 Square U-bolts x4
9/16BAG x1
10MMSTUDBAG-2 x1
Driver Side Sway Bar Drop Bracket x1
Pass Side Sway Bar Drop Bracket x1
226BAG1 x1

226BAG1

10mm-1.5x35mm Bolts x4
10mm-1.5 Nylock Nuts x4
10mm Flat Washers x8

295INSTBAG2

Instructions x1

29501Bag1

Instructions x1

10mmstudbag-2 (Strut Spacers):

10mm Stud x6
10mm Hex Nuts x1
10mm Serrated Flange Nut x6
1/2" Jam Nut x1

9/16Bag (Rear U-bolts):

9/16" Washers x8
9/16" Nuts x8

275BAG3 (Lower Strut Bolts):

10mm-1.5 x 65mm Hex Head Bolt x4
10mm Flat Washer x8
10mm-1.5 Nylock Nut x4

20158 x2



FRONT INSTALLATION

1. Park the vehicle on a level surface and chock the rear wheels. Lock the steering wheel in the straight position.
2. Jack up the front of the vehicle. Place jack stands under the frame rails and lower onto jack stands letting the front suspension hang.
3. Raise the hood and disconnect the battery using a 10mm socket.
4. Remove the tires and wheels.
5. Remove the 6 bolts holding the factory skid plates, using a 13mm socket. **See Photos 1 & 2.** Retain for later use.

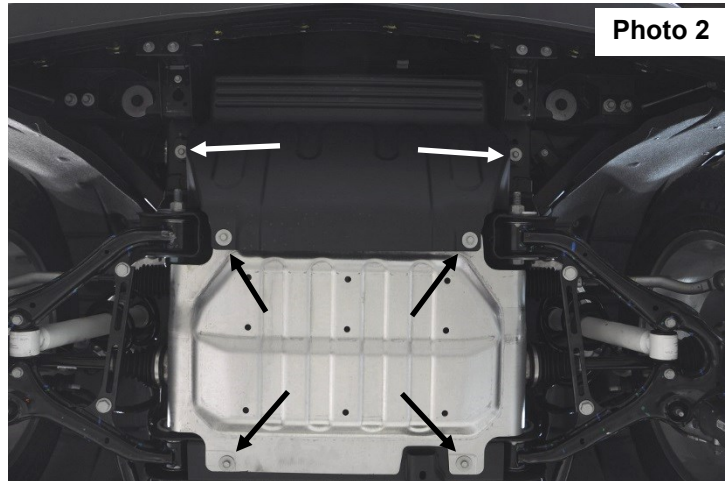

6. Unplug the three connectors going to the rack and pinion. **See Photo 3.**
7. Using a 21mm socket, remove the tie-rod nut as shown in **Photo 4.** Using a hammer, strike the front of the mount to dislodge the tie rod end. Remove from the knuckle.

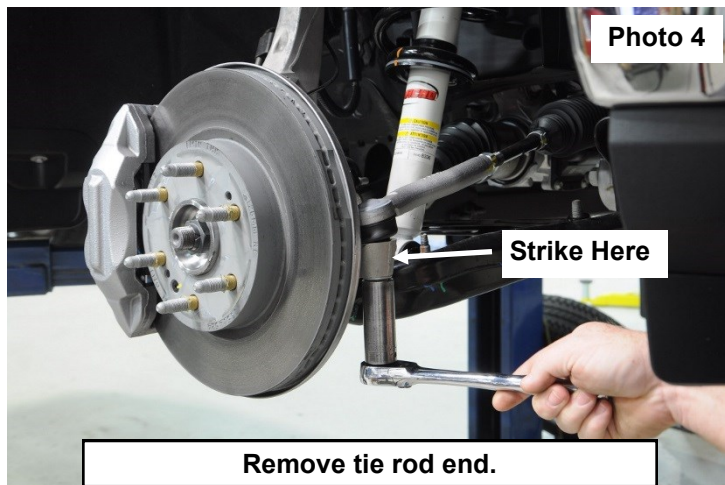
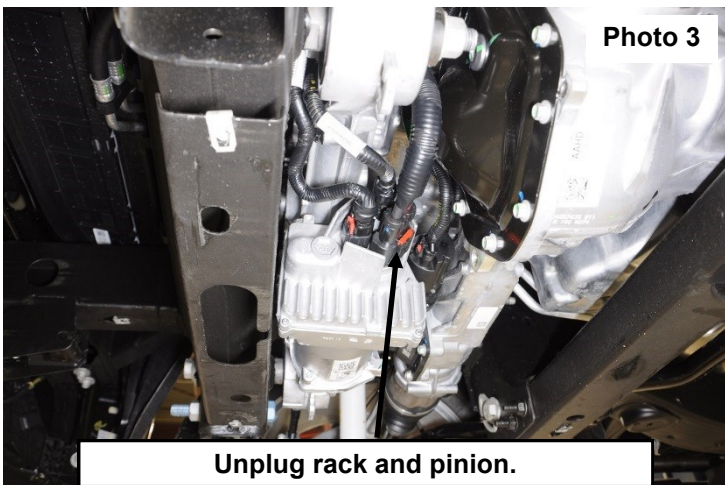

8. Unplug the brake pad sensor wire on the drivers side of the vehicle.
9. Remove the brake line from the knuckle using a 10mm socket. Retain hardware for reuse. **See Photo 5.**
10. Remove the brake caliper using a 18mm socket. Retain the bolts for reuse. **See Photo 6.** Hang caliper out of harms way. Do not hang by the brake line.

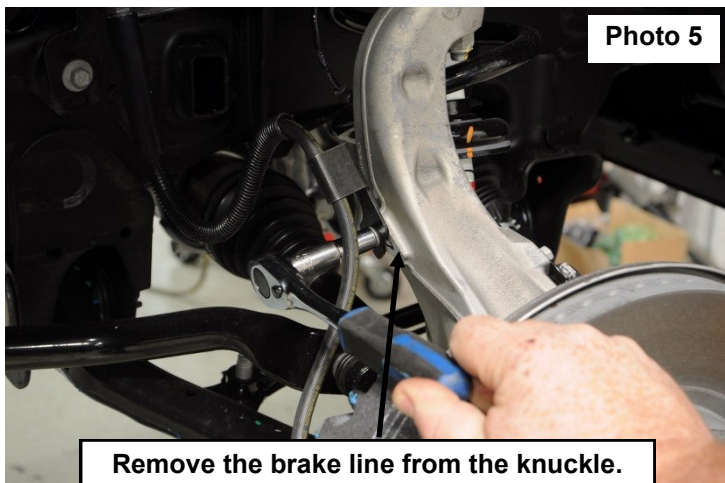

11. Remove the ABS wire bracket from the upper control arm using a 10mm socket. **See Photo 7.**
12. Using a 10mm socket, remove the ABS wire bracket from the knuckle. Retain hardware. **See Photo 8.**

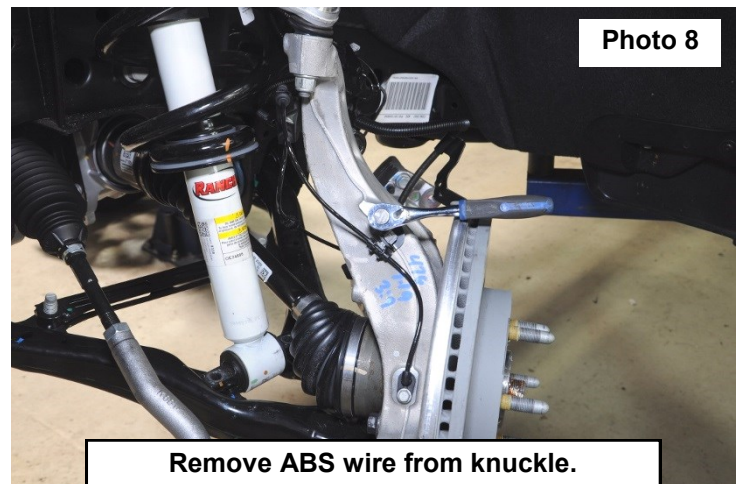
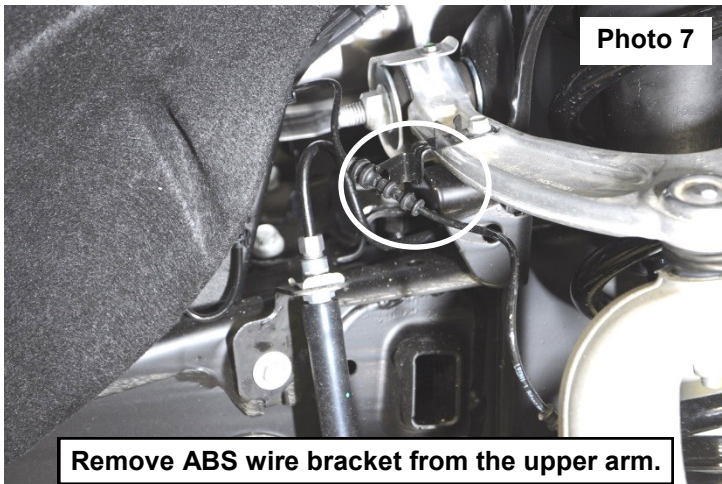

13. Using a 10mm socket, remove the ABS sensor from the knuckle. Retain hardware and hang ABS wire out of the way. **See Photo 9.**
14. Using an 18mm wrench, loosen the upper ball joint nut. Do not completely remove the nut. Strike the knuckle with a hammer to release the ball joint taper. **See Photo 10.**
15. Remove the upper control arm nut and remove the control arm from the knuckle.
16. Support the lower control arm.

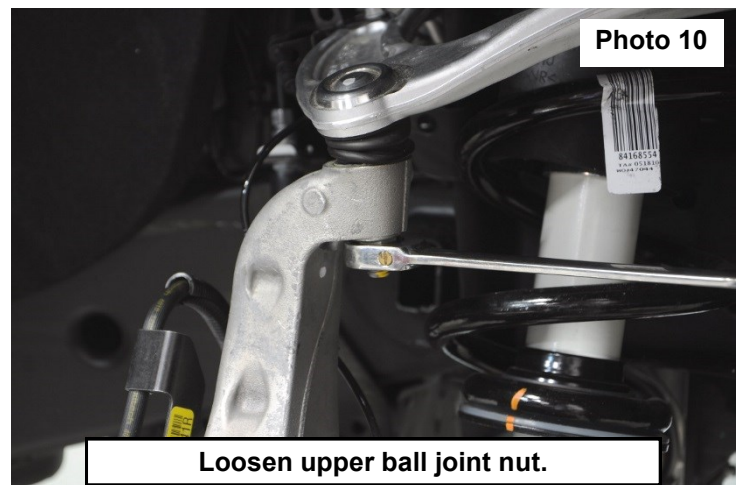
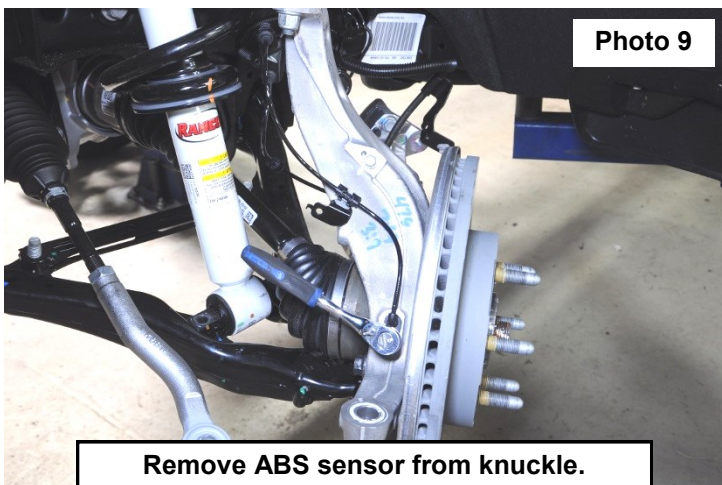

17. Remove the swaybar from the LCA and frame using an 18mm socket on the LCA and a 10mm socket on the frame. **See Photo 11.**
18. Using a 15mm socket, remove the lower strut mounting bolts. **See Photo 12.**

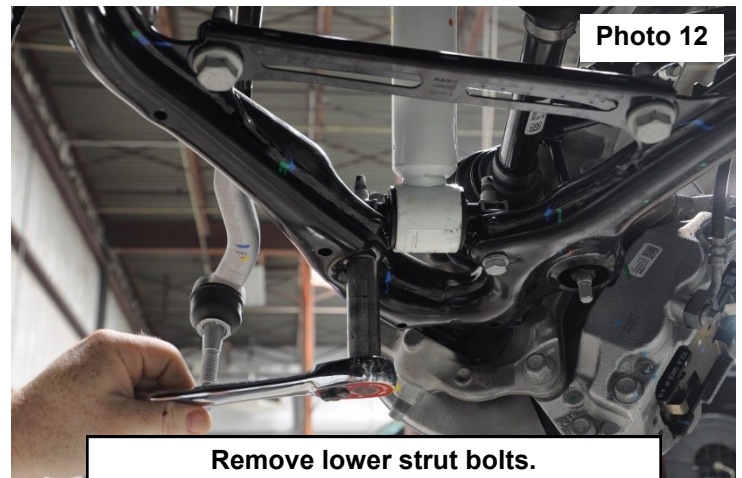
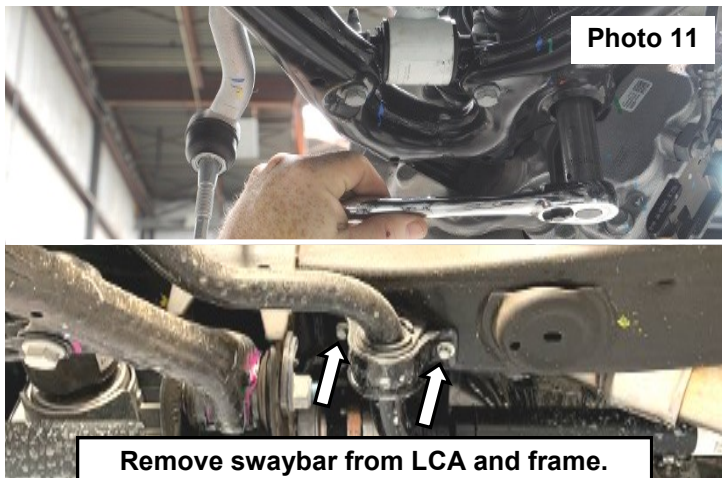

19. On the passenger side, use a 13mm socket to remove the bolt holding the plastic wire loom that is attached to the frame and the upper strut tower. Retain hardware. (Inner fender was removed for pictures) **See Photo 13.**

20. Using an 18mm wrench, remove the upper strut nuts. Retain hardware. Remove the strut from vehicle. **See Photo 14.**

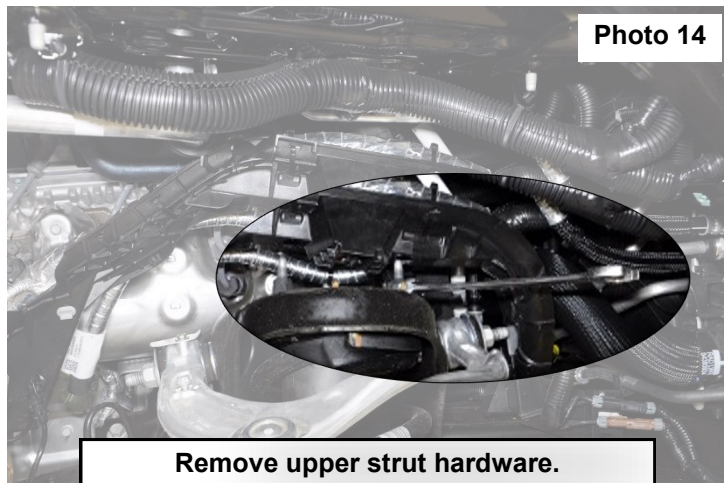
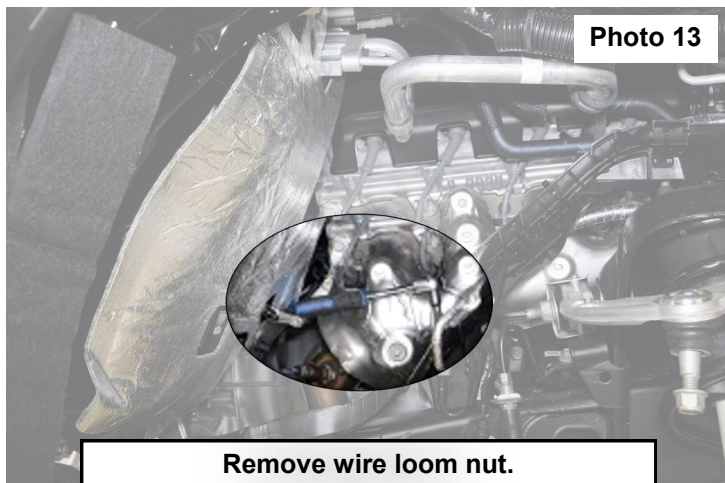

21. Place the strut into a strut compressor. Make sure to locate or mark the position of the lower bar pin. **See Photo 15**

22. Compress the spring to allow room for the preload spacer. **Photo 16.**

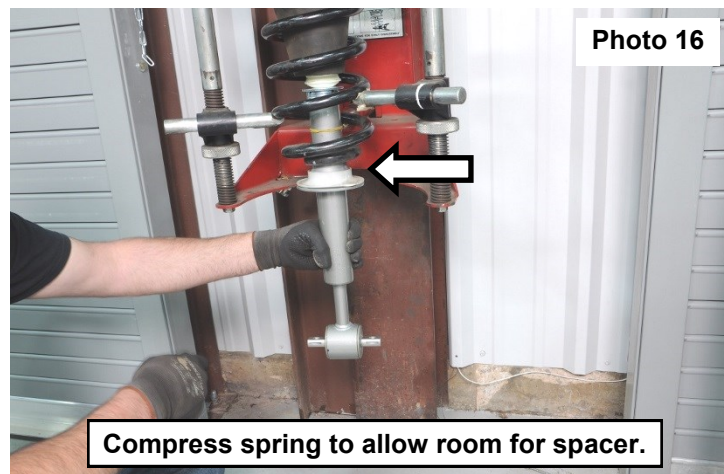
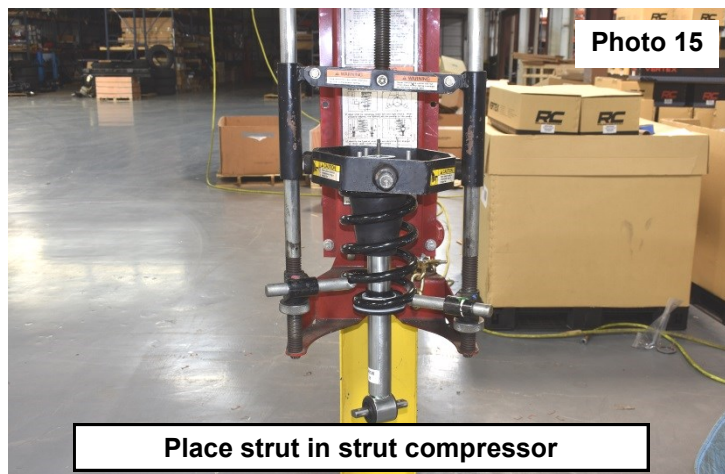

23. Place both halves of the preload spacer beneath the isolator. **See Photo 17.**

24. Interlock the two halves of the preload spacer by angling up one side and sliding it into place. **See Photo 18.**

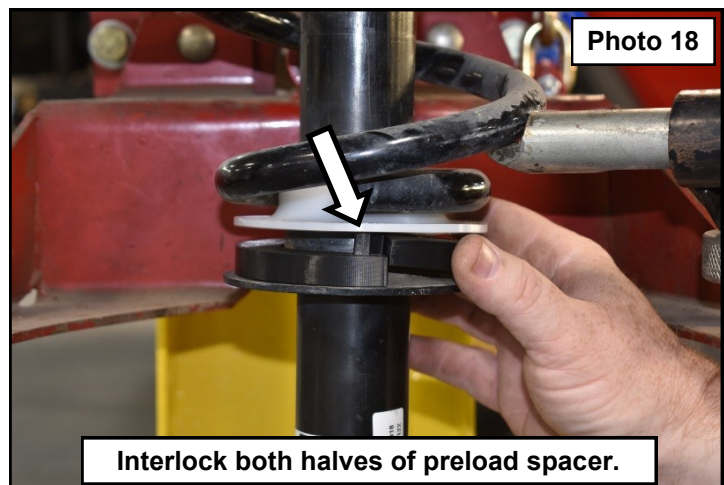
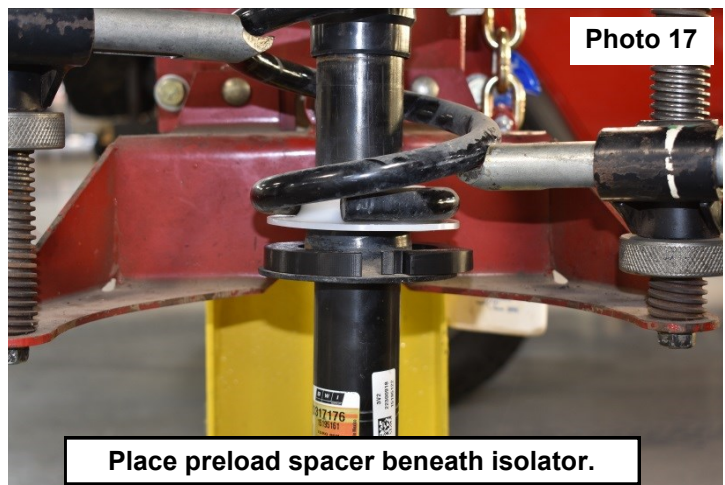

25. Completely seat the preload spacers and release the strut compressor. See Photo 19 and Photo 20.

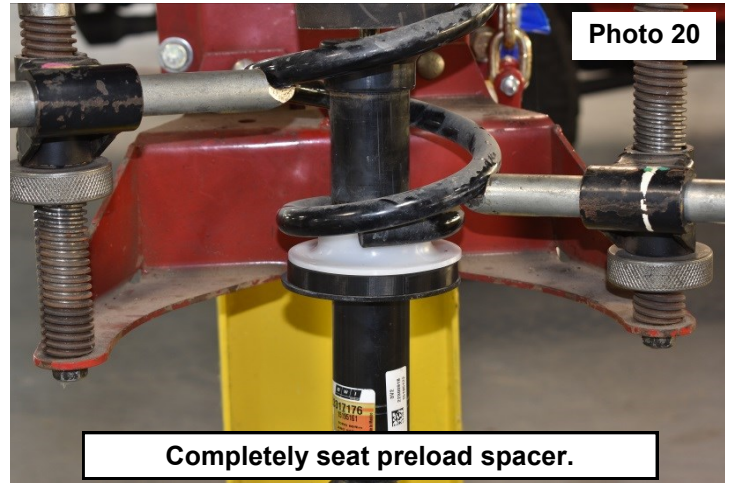
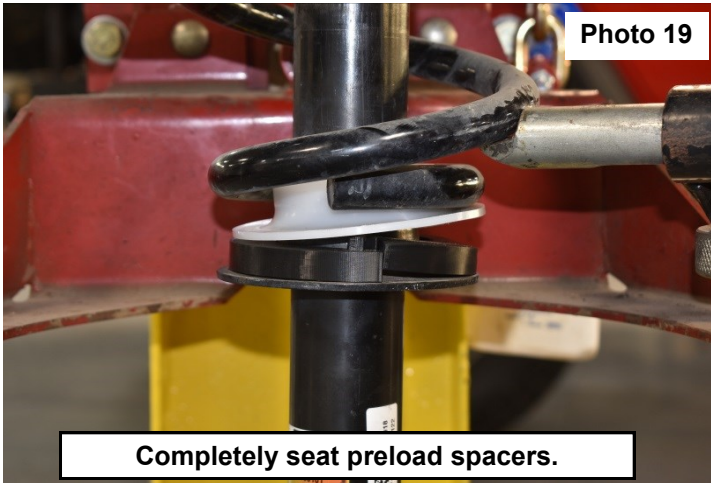

26. Measure from the top of the stud down 3/8 inch, mark the stud and cut off with a cut off wheel to clear the strut spacer with the studs installed. See Photo 21.

27. Install the 10mm studs into the smaller holes in the strut spacer, using the supplied 1/2" jam nut to slide over each stud to act as a spacer allowing you to pull the stud through the hole with the 10mm hex nut and a 17mm wrench, locking the stud into place. Remove sleeve and repeat on the other five studs. See Photo 22.

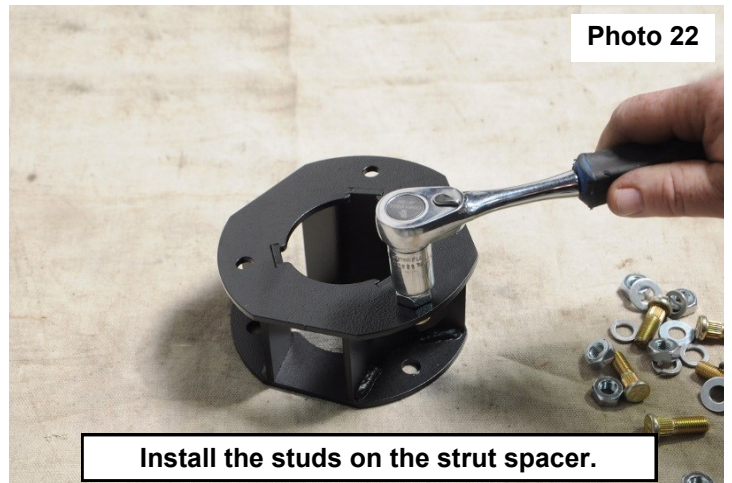
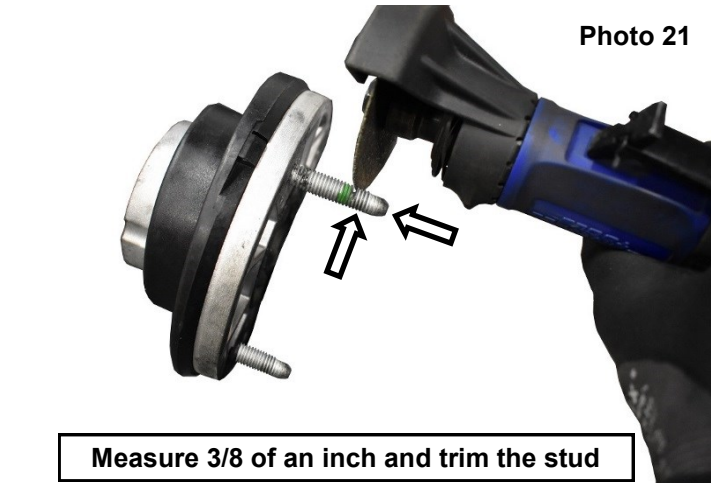

28. Install the strut spacer on top of the factory strut, secure using the OE nuts, Torque to 45 ft-lbs. using an 18mm wrench. See Photo 23.

29. Mark the location of the upper control arm. Remove the 2 bolts and nuts from the upper control arm, use a 21mm socket and wrench. See Photo 24. Save for reuse.

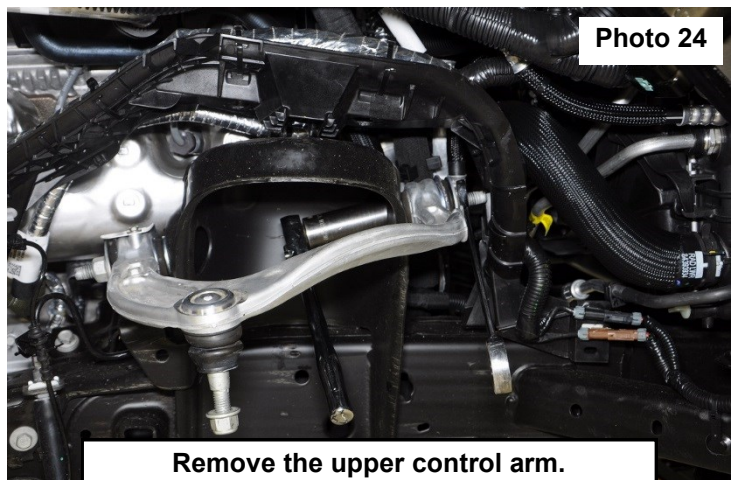
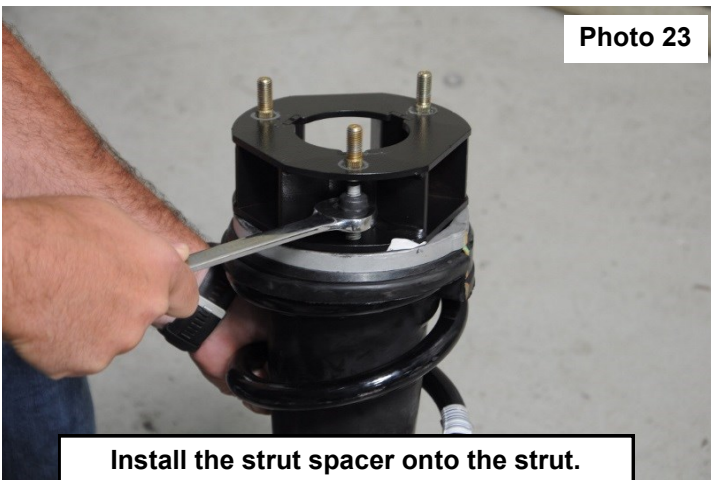

30. Remove the upper control arm from the vehicle.
31. Install the new supplied upper control arm in the stock location, using the OE hardware, align the marks made in step 30. Torque to 80 ft-lbs, using a 21mm socket and wrench. **See Photo 25.**
32. Install the strut into the factory mount on the frame, use the supplied flange nuts. (10MMSTUDBAG-2). **See Photo 26.**
Hand tighten only.

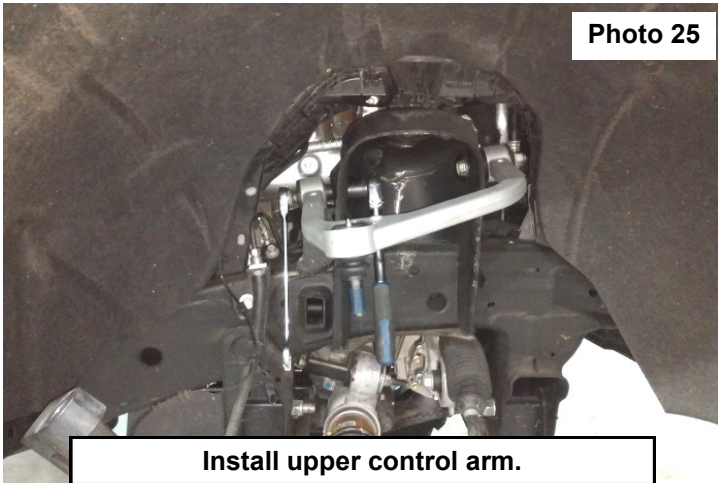

Install upper control arm.

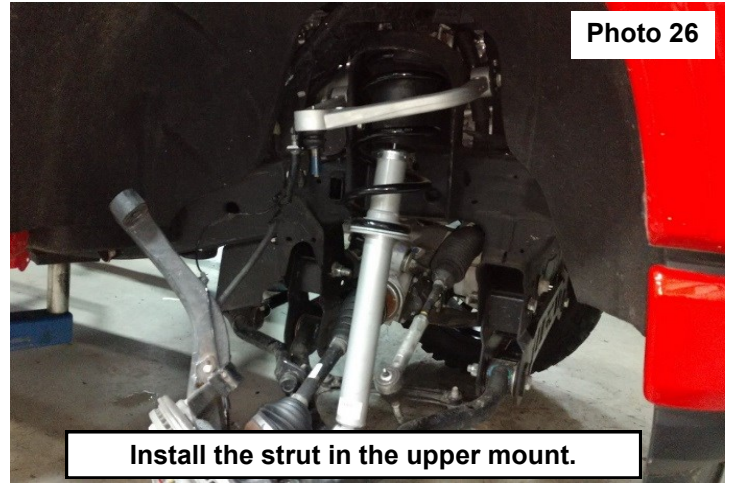

Install the strut in the upper mount.

33. Use a flat screwdriver to remove the factory clip nuts from the lower strut bar pin.
34. Install the strut into the lower control arm. **See Photo 27.**
35. Attach the lower strut mount to the lower control arm using the supplied 10mm x 65mm, washers, and nylock nuts. **Bolts will go in from the top. See Photo 28.**

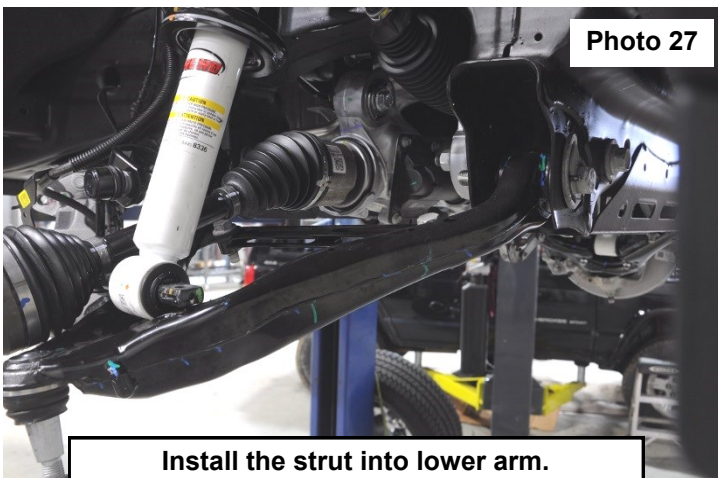

Install the strut into lower arm.

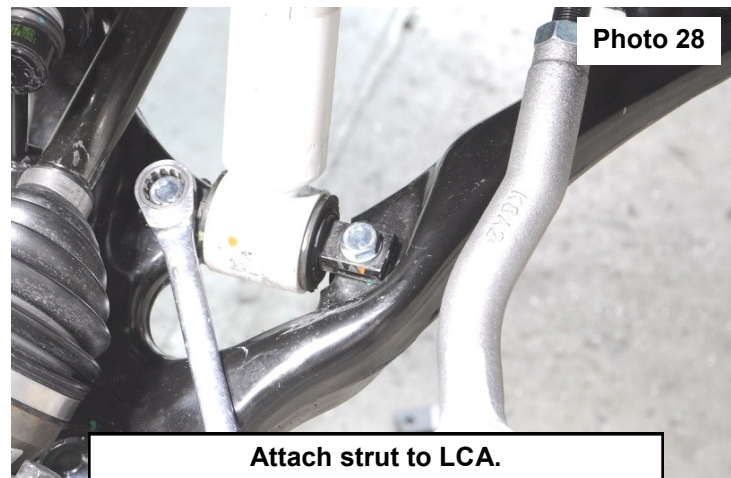

Attach strut to LCA.

36. Attach the upper ball joint using the factory hardware. Tighten using an 18mm wrench. **See Photo 29.**
37. Install the swaybar drop bracket in the factory location with the factory hardware. Install the swaybar to the bottom of the bracket using the supplied 10mm-1.5x35mm bolts, nuts, and washers. Attach the sway link to the lower control arm using the factory hardware. Tighten using a 16mm and an 18mm socket. **See Photo 30.**

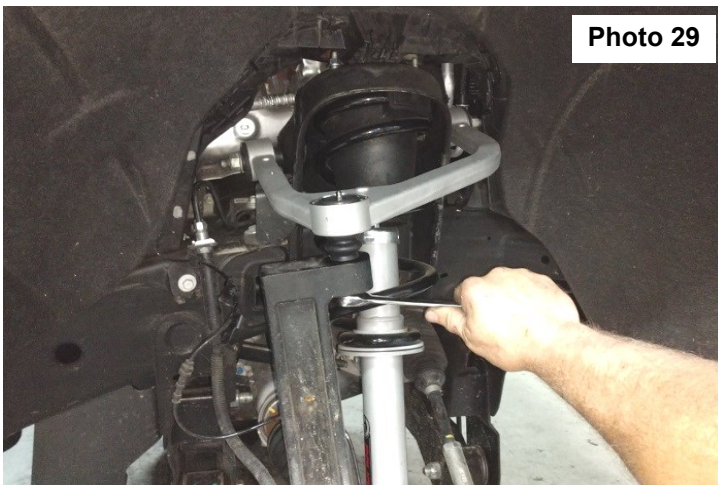

Tighten upper ball joint.

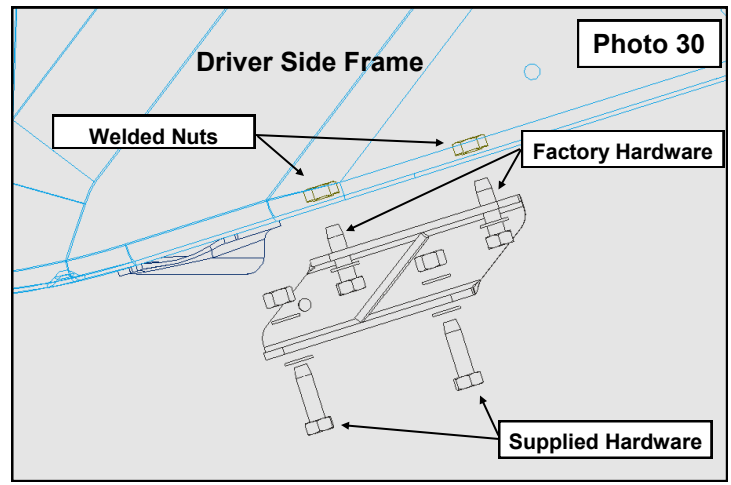

Install swaybar drop bracket and swaybar.

38. Install the ABS sensor wire bracket onto the upper control arm using the OE bolt. Tighten using a 10mm socket.

See Photo 31.

39. Attach the ABS sensor to the knuckle using the factory hardware. Tighten using a 10mm socket. **See Photo 32.**

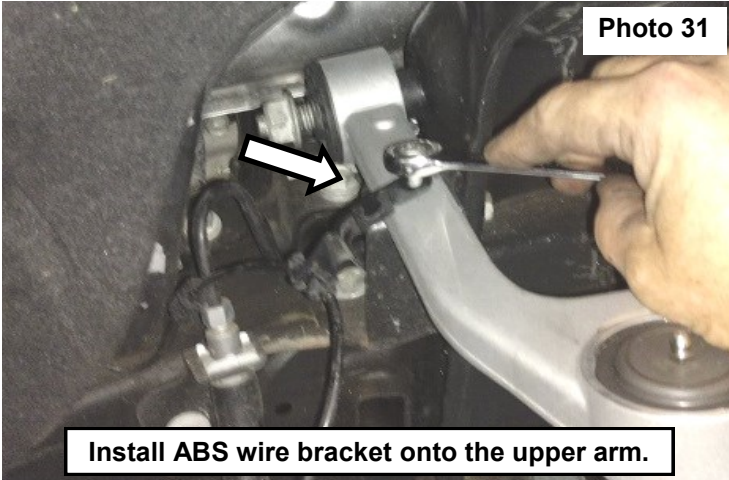

Photo 31

Install ABS wire bracket onto the upper arm.

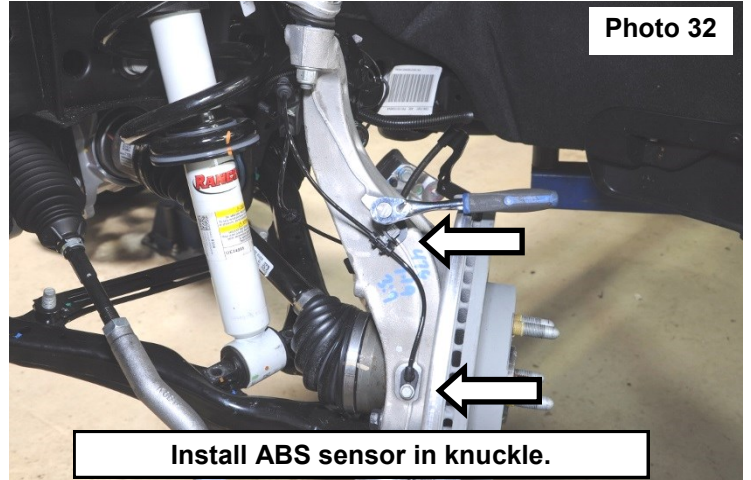

Photo 32

Install ABS sensor in knuckle.

40. Install the brake caliper onto the rotor and secure using the retained bolts. Torque the caliper bolts to 130 ft-lbs. using an 18mm socket. Install brake line onto the knuckle using the retained bolt. Tighten using a 10mm wrench. **See Photo 33.**

41. Attach brake line to the knuckle using the factory hardware. Tighten using a 10mm socket. **See Photo 34.**



Photo 33

Install the brake caliper.

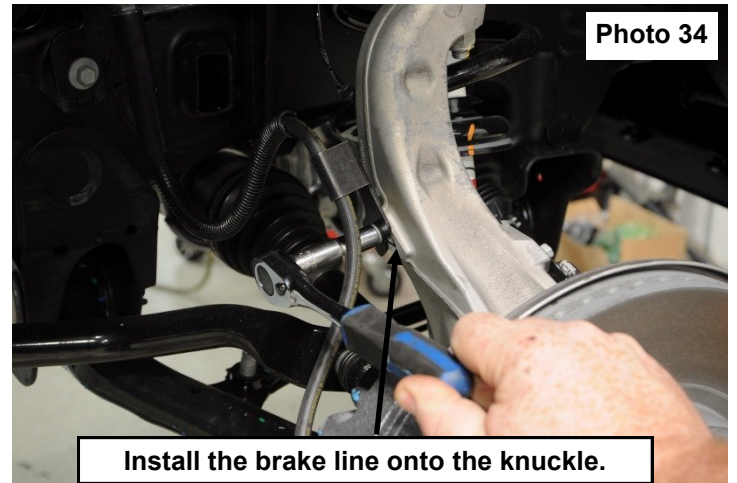

Photo 34

Install the brake line onto the knuckle.

42. Plug up the brake pad wear sensor. **See Photo 35.**

43. Attach the tie rod end to the knuckle using factory hardware. Tighten using a 21mm wrench. **See Photo 36.**

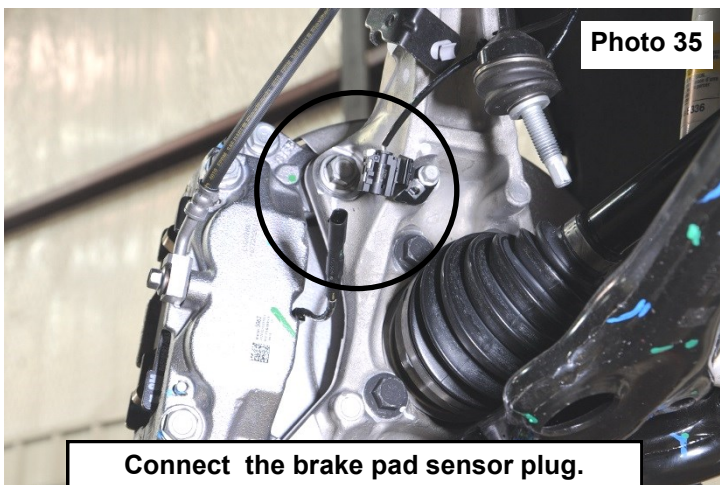

Photo 35

Connect the brake pad sensor plug.

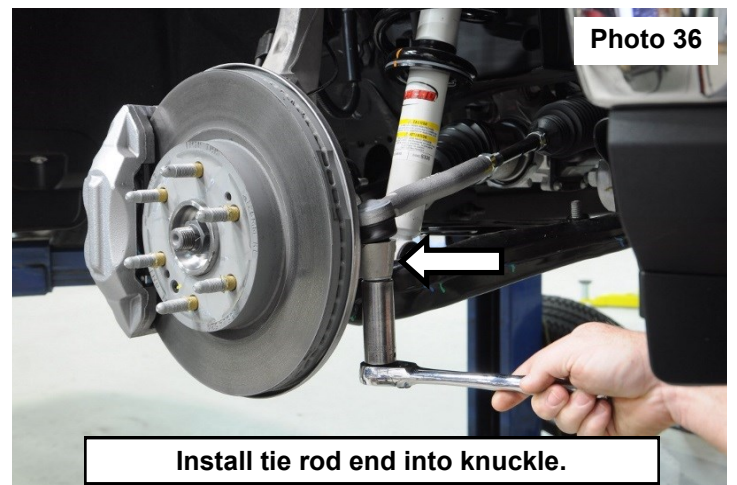

Photo 36

Install tie rod end into knuckle.

44. Repeat steps 6-44 on the opposite side of the vehicle.

45. Reconnect the plugs to the rack and pinion and the differential actuator. **See Photo 37.**

46. Install the factory skid plates using the retained hardware, using a 13mm socket. Torque to 32 ft-lbs. **See Photo 38.**

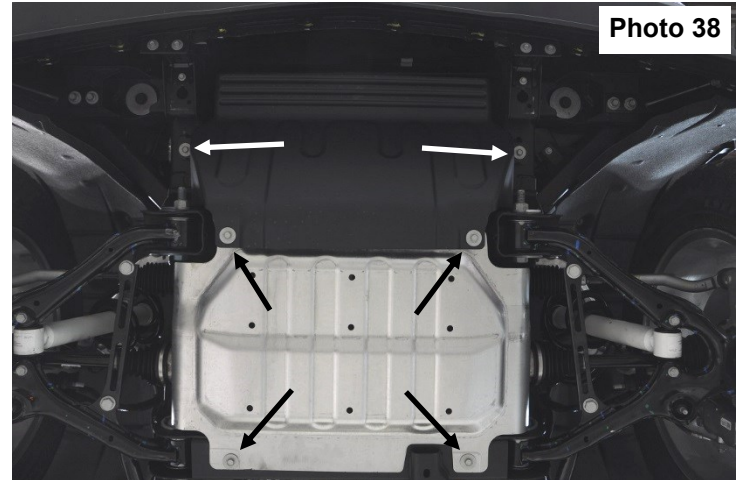
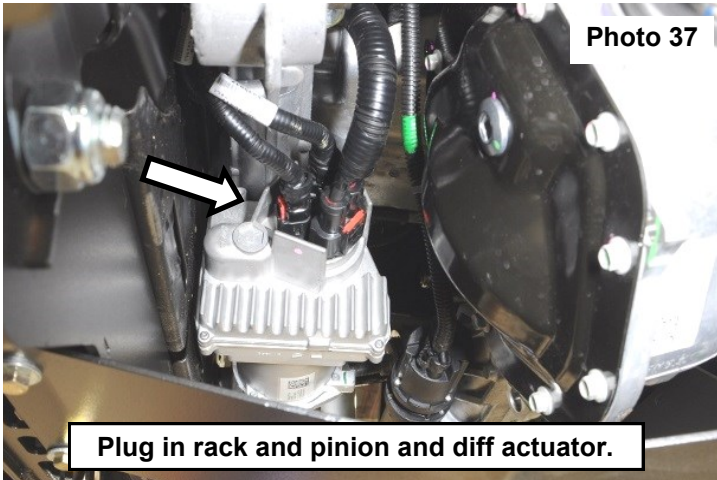

47. Install the wheels and tires.

48. Jack up the truck and remove the jack stands. Lower the truck to the ground.

49. Connect the battery cables to the battery.

⚠ WARNING Take caution when installing the wheels, making sure they completely clear the brake caliper. Any pressure on the brake caliper from the wheel will cause an error in the brake system. The braking system will not function properly. The vehicle will have to be reset by a GM dealership.

REAR INSTALLATION

1. Chock the front tires.
2. Jack up the rear of the truck and place jack stands under the frame rails, lower the truck onto the jack stands allowing the rear suspension to hang. Place a jack under the rear differential.
3. Using a 21mm wrench, remove the upper rear shock hardware. Retain hardware. **See Photo 1.**
4. Using a 21mm wrench and socket, remove the rear shock from the axle. Retain hardware. **See Photo 2.**

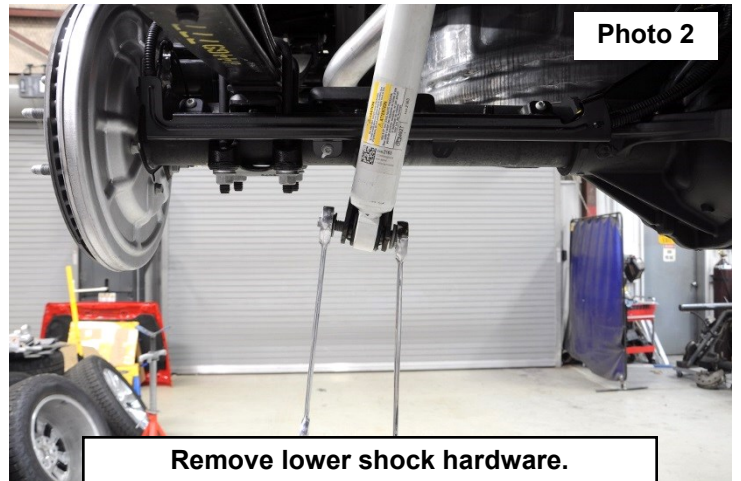
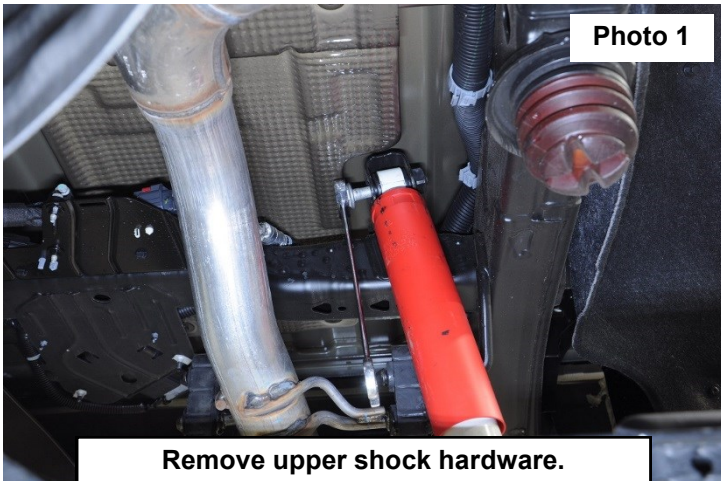

5. Using a 13mm wrench, remove the 3 bolts from the ABS/brake line bracket on the rear differential. **See Photo 3.** Retain bolts for later use.
6. Using a 21mm deep well socket, remove the rear u-bolts. **See Photo 4.**
7. Lower the rear axle and remove the factory blocks.

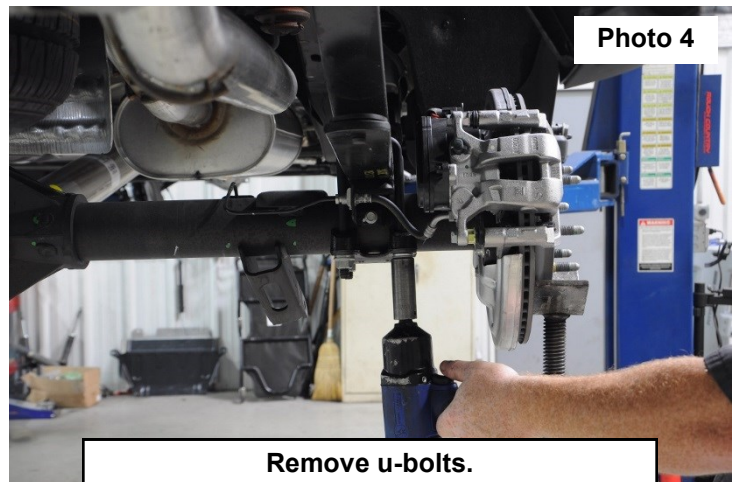
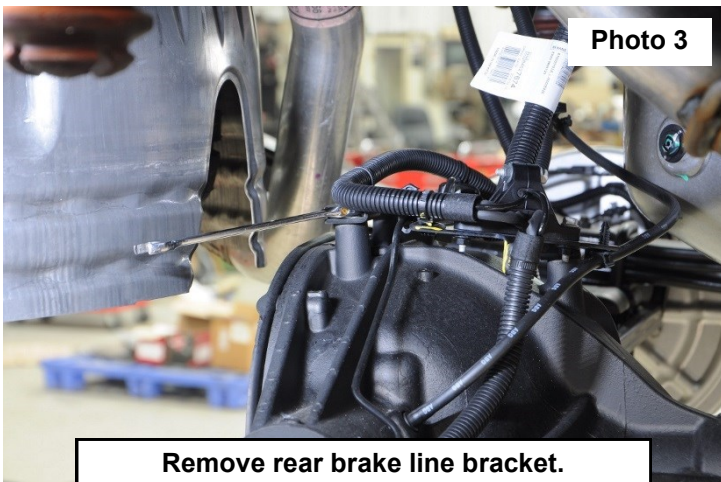

8. Install the supplied rear blocks (larger end of the block to the rear) and u-bolts. Tighten the u-bolts using a 22mm socket. Torque to 90ft/lbs **See Photos 5 & 6.**
9. Install the supplied shocks (660739) using the factory hardware. Torque to factory specs using a 21mm wrench and

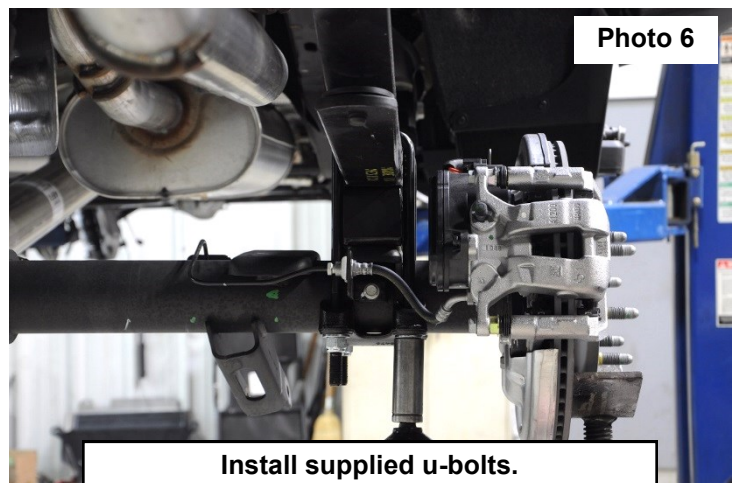
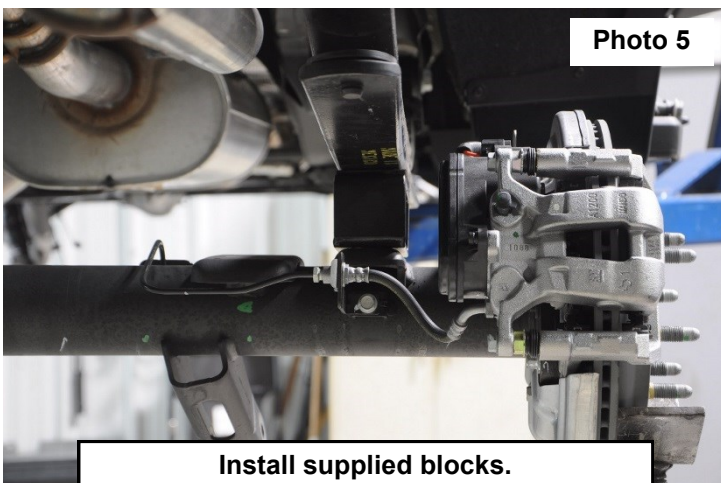

socket. **See Photo 7.**

10. Install the 3 retained bolts in the ABS/brake line bracket on the rear differential. Tighten using a 13mm wrench . **See Photo 8.**

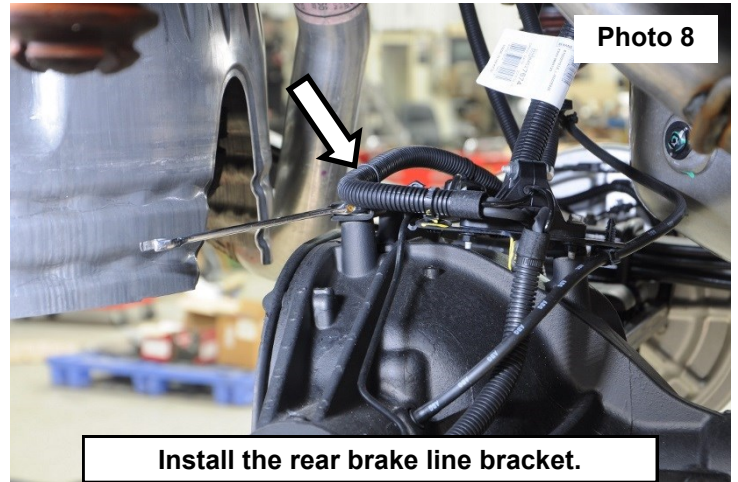
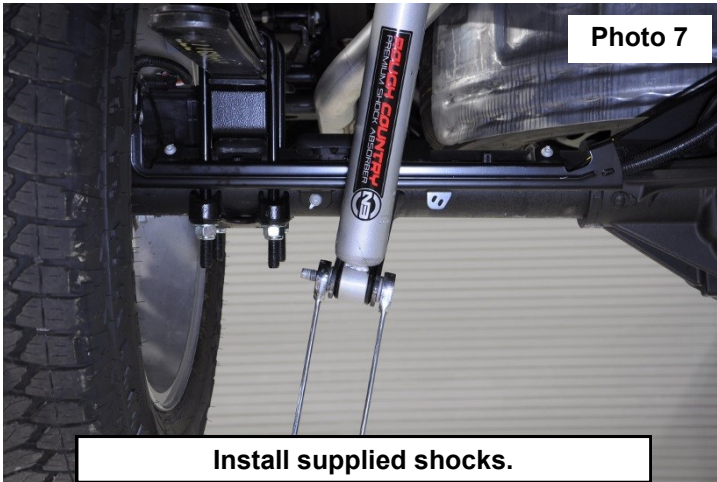

⚠ WARNING Take caution when installing the wheels, making sure they completely clear the brake caliper. Any pressure on the brake caliper from the wheel will cause an error in the brake system. The braking system will not function properly. The vehicle will have to be reset by a GM dealership.

11. Re-install tires and wheels.
12. Remove jack stands and lower vehicle to ground.
13. Place shock decals on shock absorbers and window decal on vehicle.

POST INSTALLATION INSTRUCTIONS

1. Check all fasteners for proper torque. Check to ensure for adequate clearance between all rotating, mobile, fixed, and heated members. Verify clearance between exhaust and brake lines, fuel lines, fuel tank, floor boards and wiring harness. Check steering gear for clearance. Test and inspect brake system.
2. Perform steering sweep to ensure front brake hoses have adequate slack and do not contact any rotating, mobile or heated members. Inspect rear brake hoses at full extension for adequate slack. Failure to perform hose check/ replacement may result in component failure.
3. On some vehicles the front lower skirting will need to be trimmed if using certain wheel /tire combinations and with heavy offset wheels. Trim only as needed.
4. Activate four wheel drive system and check front hubs for engagement.
5. Have a qualified alignment center align the vehicle immediately. Realign to factory specifications. The following are the recommended specifications:

Caster in degrees	4.0 +-1.0
Camber in degrees	-.4 +- .8
Toe In in degrees	0.1 +- .2
6. Perform head light check and adjustment to proper settings.
7. Check and retighten wheels at 50 miles and again at 500 miles.
8. All kit components must be retightened at 500 miles and then every three thousand miles after installation. Periodically check all hardware for tightness.
9. Install "Warning to Driver" decal on sun visor

Note: Installation of larger tires will require speedometer recalibration.

Thank you for choosing Rough Country for all of your suspension needs.

By purchasing any item sold by Rough Country, LLC, the buyer expressly warrants that he/she is in compliance with all applicable Federal, State, and Local laws and regulations regarding the purchase, ownership, and use of the item. It shall be the buyers responsibility to comply with all Federal, State and Local laws governing the sales of any items listed, illustrated or sold. The buyer expressly agrees to indemnify and hold harmless Rough Country, LLC for all claims resulting directly or indirectly from the purchase, ownership, or use of the items.



