



RAM 2012-17 4WD 1500 3” Leveling Kit

Thank you for choosing Rough Country for all your suspension needs.

DOES NOT FIT TRX PACKAGE VEHICLES!!

Rough Country recommends a certified technician install this system. In addition to these instructions, professional knowledge of disassemble/reassembly procedures as well as post installation checks must be known. Attempts to install this system without this knowledge and expertise may jeopardize the integrity and/or operating safety of the vehicle.

Please read instructions before beginning installation. Check the kit hardware against the kit contents list on the back page. Be sure you have all needed parts and know where they go. Also please review tools needed list and make sure you have the tools needed to install the kit.

PRODUCT USE INFORMATION

⚠ WARNING

As a general rule, the taller a vehicle is, the easier it will roll. Seat belts and shoulder harnesses should be worn at all times. Avoid situations where a side rollover may occur.

Generally, braking performance and capability are decreased when larger/heavier tires and wheels are used. Take this into consideration while driving. Do not add, alter, or fabricate any factory or after-market parts to increase vehicle height over the intended height of the Rough Country product purchased. Mixing component brands is not recommended.

Rough Country makes no claims regarding lifting devices and excludes any and all implied claims. We will not be responsible for any product that is altered.

We will be happy to answer any questions concerning the design, function, and use of our products.

This suspension system was developed using a 33X12.50/17, tire with factory wheels.

⚠ NOTICE NOTICE TO DEALER AND VEHICLE OWNER

Any vehicle equipped with any Rough Country product should have a “Warning to Driver” decal installed on the inside of the windshield or on the vehicle’s dash. The decal should act as a constant reminder for whoever is operating the vehicle of its unique handling characteristics. By purchasing any item sold by Rough Country, LLC, the buyer expressly warrants that he/she is in compliance with all applicable Federal, State, and Local laws and regulations regarding the purchase, ownership, and use of the item. It shall be the buyers responsibility to comply with all Federal, State and Local laws governing the sales of any items listed, illustrated or sold. The buyer expressly agrees to indemnify and hold harmless Rough Country, LLC for all claims resulting directly or indirectly from the purchase, ownership, or use of the items.

⚠ NOTICE

INSTALLING DEALER - it is your responsibility to install the warning decal and forward these installation instructions on to the vehicle owner for review. These instructions should be kept in the vehicle for its service life.

⚠ NOTICE

Note to installer : Before installation begins we recommend that a test drive be performed. While driving check for uncommon sounds and/or vibrations . What you feel and hear during the test drive will only magnify once lift kit is installed. Advise you to discuss possible issues identified from drive with customer before proceeding to install this kit.

Tools Needed:

- 8mm Wrench
- 15mm Socket / Wrench
- 14mm Socket / Wrench
- 17mm Socket / Wrench
- 18mm Socket / Wrench
- 21mm Socket / Wrench
- 22mm Socket / Wrench
- 24mm Socket / Wrench

Torque Specs:

Size	Grade 5	Grade 8
5/16”	15 ft/lbs	20 ft/lbs
3/8”	30 ft/lbs	35 ft/lbs
7/16”	45 ft/lbs	60 ft/lbs
9/16”	95 ft/lbs	130 ft/lbs
	Class 8.8	Class 10.9
10MM	32ft/lbs	45ft/lbs
18MM	170ft/lbs	240ft/lbs



INSTALLATION INSTRUCTIONS

1. Jack up the front of the vehicle and support the vehicle with jack stands, so that the front wheels are off the ground.
2. Using 22mm socket remove the front tires/wheels.
3. Using 21mm socket remove the nut from the steering linkage. Using a hammer hit on the side of the knuckle as shown, and remove the linkage from the knuckle. Push linkage forward to make room for installation. Retain factory hardware **See Photo 1**.
4. Using a 15mm wrench, remove the sway bar nut, and bushings allowing the sway bar to drop. Retain factory hardware. **See Photo 2**.

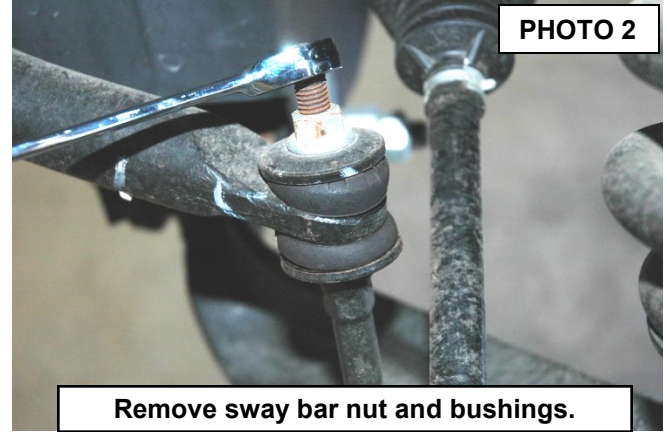

5. Using a 15mm socket, remove the strut nuts on the upper strut tower. **See Photo 3**
6. Place jack stand under the knuckle for support. Using 21 mm socket remove upper ball joint nut. Using a hammer hit the knuckle to allow the ball joint to separate from the upper control arm **See Photo 4**. Do not allow the knuckle to pull out far enough that it pulls the shaft out of the differential.

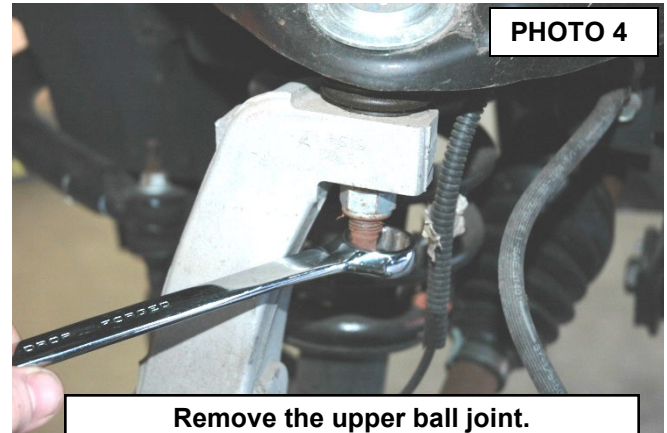
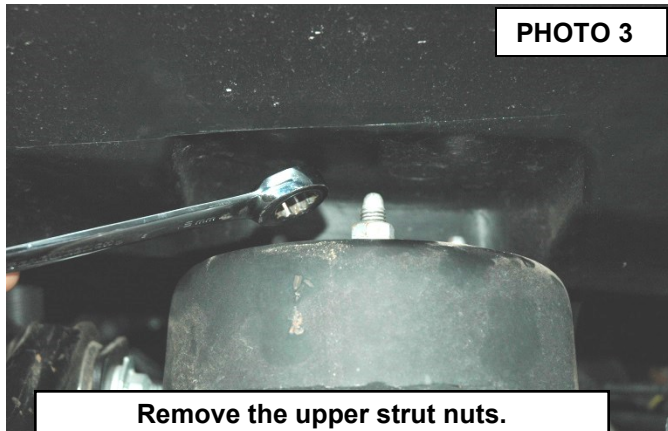

7. Using a 24mm socket and 21mm wrench, remove the strut bolt from the lower control arm and remove the strut assembly from the vehicle. Retain the factory lower bolt for reassembly. Note the direction of the bolt for reassembly. **See Photo 5**.

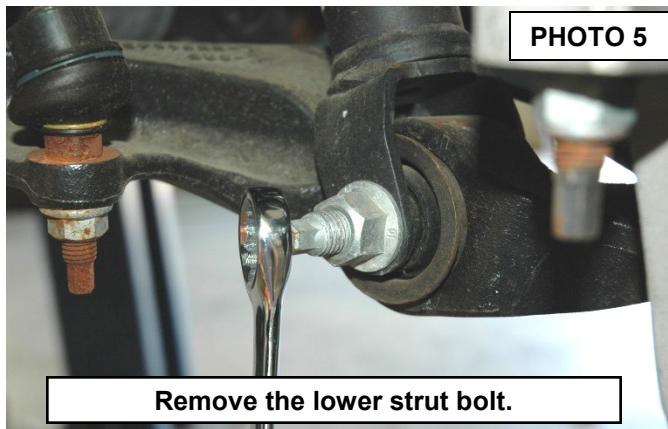

8. Using an 18mm wrench, remove the upper control arm bolts and retain for reuse. Also, remove the upper control arm from the knuckle. **See Photos 6 & 7.**



9. Place a strut compressor on the coil spring and compress the coil, so the strut top nut can be removed. Next remove the strut top and add the preload spacer to the coil assembly. The spacer will fit between the factory coil isolator and the strut top. **See Photo 8.**
10. Using the 1/2" jam nut and one of the 10mm nuts, from 10mmstudbag-1, install the supplied studs into the upper strut spacers.
11. Install the strut spacer onto the strut using the factory hardware. Torque to factory specs using a 15mm wrench. **See Photo 9.**

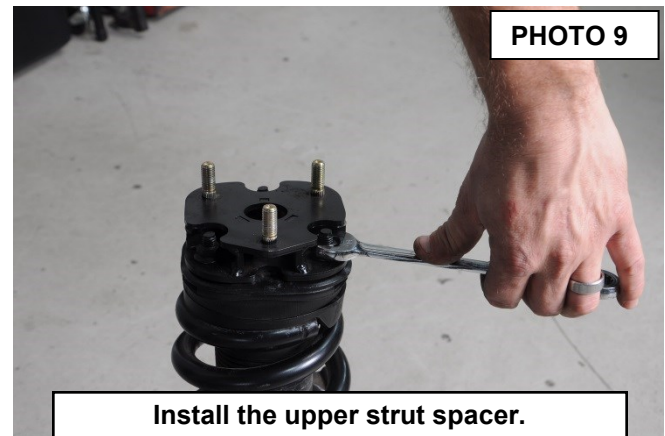
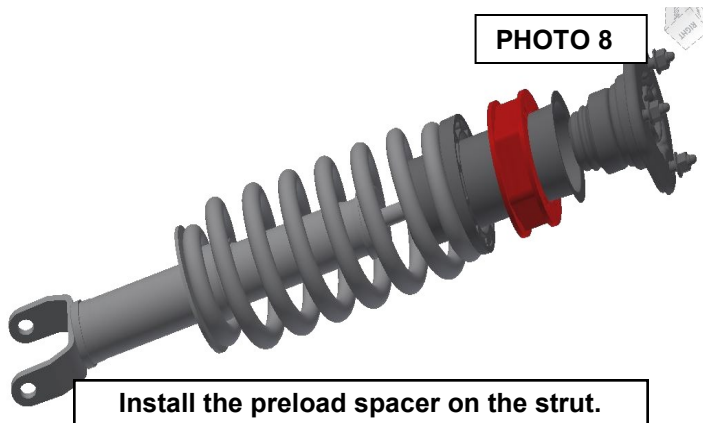

12. Install the strut assembly into the strut tower using the supplied hardware from 10mmstudbag-1. Install on the lower control arm using the factory hardware. Tighten the upper nuts using a 17mm wrench and the lower using a 24mm socket and 21mm wrench.
13. Install the new Rough Country upper control arms using the factory hardware on the frame mounts and the supplied hardware on the ball joint. Ball joint spacer from 3825BAG will be placed between the knuckle and the nut. Torque to factory specs. **See Photos 10 & 11. Refer to last page for Dr/Pass side control arm difference.**

▲ NOTICE Ball joint must be greased before use.
Check ball joint grease after the first 100 miles and then every 3000 miles.

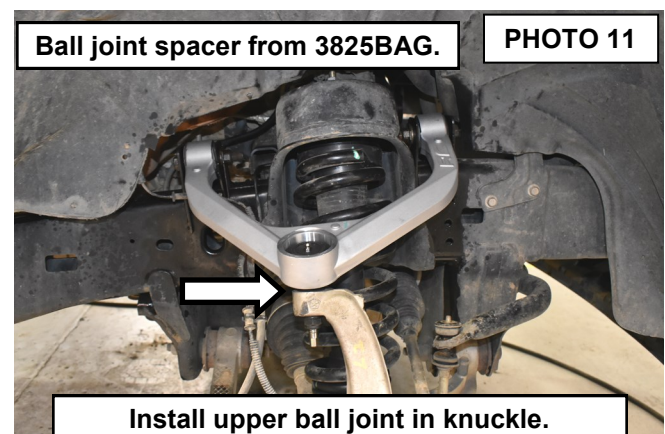
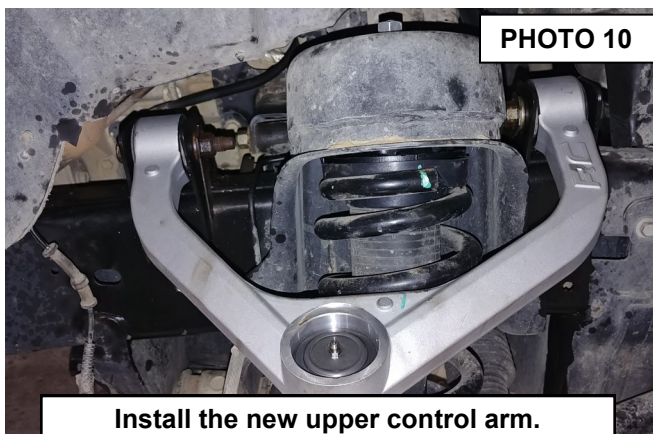

14. Using a floor jack, raise the lower control arm and connect the upper ball joint on the upper control arm to the spindle. Torque to manufacturer specs.
15. Using a 21mm socket reinstall the steering linkage nut .
16. Repeat steps 3-15 on opposite side of vehicle
17. Using 15 mm wrench reinstall sway bar bushings and nut using factory hardware. Torque to factory specs.
18. Install the wheels / tires.
19. Jack up the vehicle and remove the jack stands. Lower the vehicle to the floor and torque all bolts to factory specifications.

REAR INSTALLATION

1. Jack up the rear of the vehicle and place jack stands underneath the frame rail.
2. Support the rear axle with a floor jack.
3. Remove the tires and wheels.
4. Remove the stock shocks from the lower shock mount using a 21mm wrench. **See Photo 1.**
5. Remove the sway bar link from the sway bar using a 18mm and 8mm wrench. **See Photo 2.**
6. Lower the axle with the floor jack and remove the coils springs. **See Photo 3.**

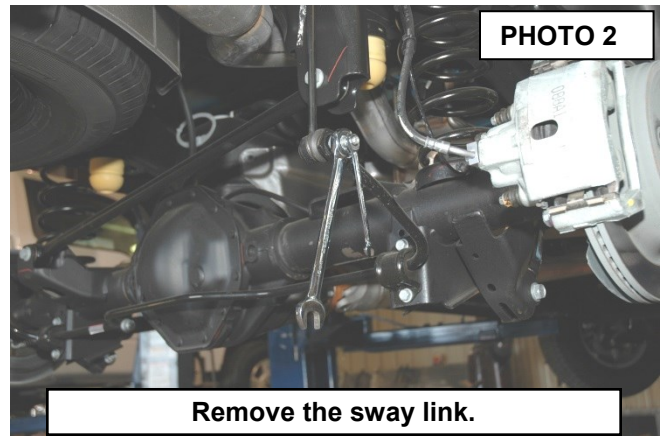
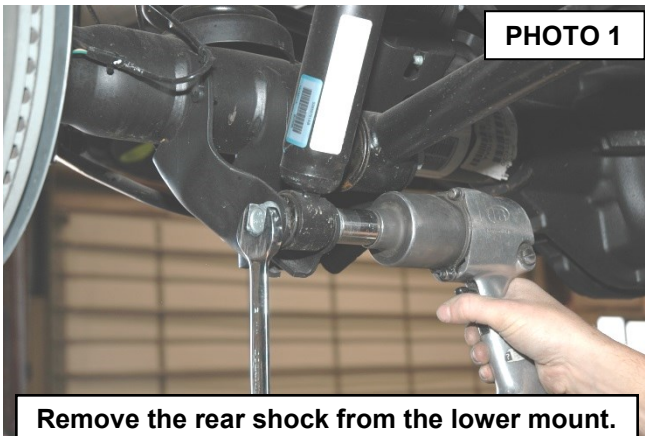

7. Install the flat upper spacer retainer as shown in **Photo 4** on the upper coil seat.

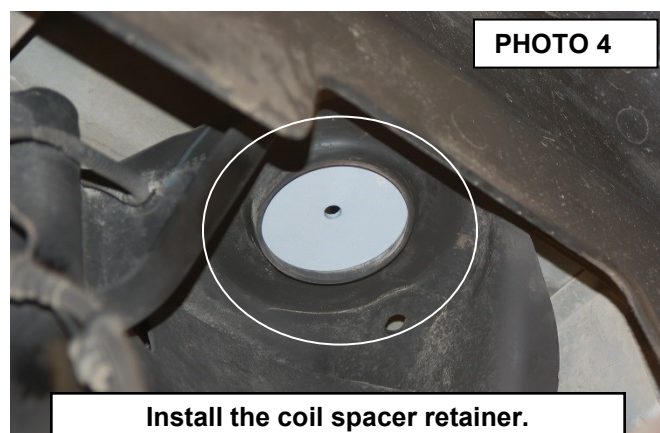
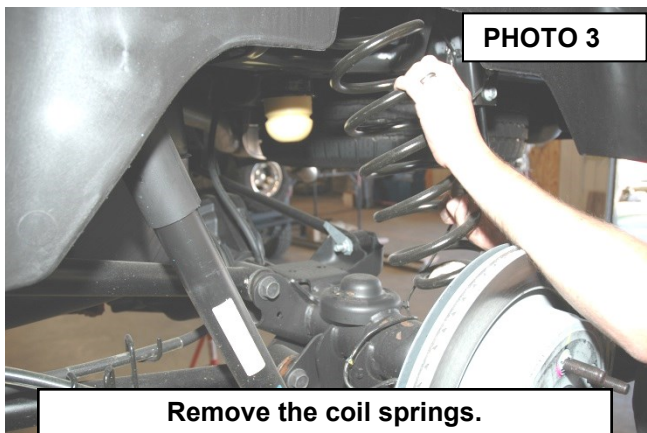

8. Install the rubber spring isolator on the rear spring spacer. **See Photo 5.**
9. Install the rear spring spacer and secure with the supplied 3/8" x 2 1/2" bolt through the upper flat retainer to hold the spacer in place. Tighten using a 14mm Socket & wrench. **See Photo 6.**



PHOTO 5

Install spring isolator on spring spacer.



PHOTO 6

Install the rear coil spacer.

10. Reinstall the coil spring.
11. Lift the axle with the floor jack and reinstall the stock shocks with the stock hardware using a 21mm wrench.
12. Reinstall the sway bar link on the sway bar using a 18mm and 8mm wrench.
13. Reinstall the tires /wheels and remove the jack stands.
14. Lower the vehicle to the ground.

POST INSTALLATION

1. Check all fasteners for proper torque. Check to ensure there is adequate clearance between all rotating, mobile, fixed and heated members. Check steering for interference and proper working order. Test brake system.
2. Perform steering sweep. The distance between the tire sidewall and the brake hose must be checked closely. Cycle the steering from full turn to full turn to check for clearance.
3. Re torque all fasteners after 500 miles. Visually inspect components and re torque fasteners during routine vehicle service.
4. Readjust headlights to proper settings and take truck in for a front-end alignment to a qualified alignment professional.

KIT CONTENTS:

- 2-Upper Control Arms
1-3825BAG
2-Ball Joint Spacers
- 2-Front Strut Preload Spacers
- 2-Front Strut Spacers
- 2-Rear Coil Spacers
- 2-Rear Retaining Washers
1-359Bag2 Includes:
2-3/8" x 2 1/2" Bolts
2-3/8" Nylock Nuts
4-3/8" Flat Washers



Thank you for purchasing a Rough Country Leveling System.

By purchasing any item sold by Rough Country, LLC, the buyer expressly warrants that he/she is in compliance with all applicable Federal, State, and Local laws and regulations regarding the purchase, ownership, and use of the item. It shall be the buyers responsibility to comply with all Federal, State and Local laws governing the sales of any items listed, illustrated or sold. The buyer expressly agrees to indemnify and hold harmless Rough Country, LLC for all claims resulting directly or indirectly from the purchase, ownership, or use of the items.



Driver Arm

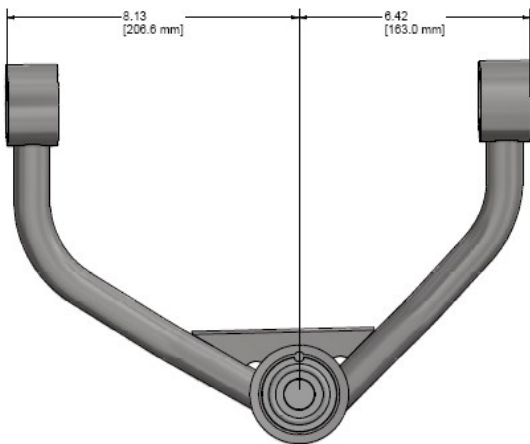

Passenger Arm

